

# TECHNISCHE FICHE

## RONDE SCHARNIERHAAK Ø 60 MM MET MUURPIN

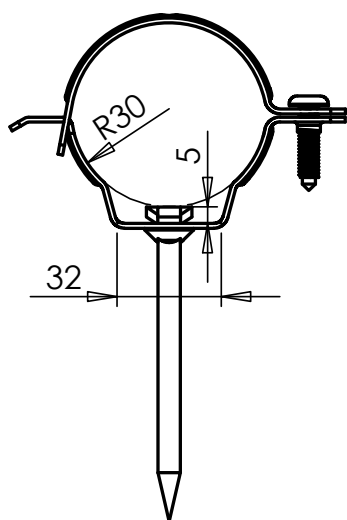

art nr	materiaal	dikte	breedte	afwerking	gewicht	verpakking
SCHR60-G	ijzer (NEN-EN10139)	1.5 mm	30 mm	thermisch verzinkt ( $\geq 55 \mu\text{m}$ )	133 g	25 st/doos
SCHR60-IN	roestvast staal 1.4301	1.5 mm	30 mm	-	133 g	25 st/doos
SCHR60-K	koper (NEN-EN 1172)	1.5 mm	30 mm	-	149 g	25 st/doos
SCHR60-ZW	ijzer (NEN-EN10139)	1.5 mm	30 mm	thermisch verzinkt ( $\geq 55 \mu\text{m}$ ) + poedercoating RAL 9035 ( $\geq 60 \mu\text{m}$ )	133 g	25 st/doos



Synoniem van KWALITEIT en  
SERVICE

APOK KAMPENHOUT  
administratieve hoofdzetel  
Oudestraat 11, B-1910 Kampenhout  
Tel.: +32 (0)16 61 72 62 - Fax: +32(0)16 61 72 81  
Website: [www.apok.be](http://www.apok.be) - E-mail: [info@apok.be](mailto:info@apok.be)

